

# The Scripps Oceanography 100 Island Challenge

*Developing conservation targets for coral reefs globally*



**Principal Investigator:**

**Co-Principal Investigator:**

**Project Coordinator:**

**Stuart Sandin** (ssandin@ucsd.edu)

**Jennifer Smith** (smithj@ucsd.edu)

**Brian Zgliczynski** (bzgliczy@ucsd.edu)

**Website:**

**100IslandChallenge.org**



## SUMMARY

Coral reefs cover less than 0.1% of the Earth's surface, yet are estimated to support greater than 25% of marine biodiversity. For the hundreds of millions of people living adjacent to coral reefs, this productive ecosystem provides important shoreline protection and critical food security. Alarming, a combination of local human influences and global climatic changes are altering the structure and functioning of many reef ecosystems.

For years, our team at Scripps Institution of Oceanography has been working to establish a regional scale perspective of coral reef health, investigating how reefs are structured, how they change over time, and how we can better manage them in the face of global change. To accelerate this crucial effort, we have established a large-scale field campaign across the tropical Pacific and beyond that will generate critical data about reef ecosystems through time.

By using a collection of survey technologies coupled with ecological theory and quantitative models, we will gain important insights into the relative condition of coral reefs from across locations, using large-scale geographic scope to provide context for comparisons across locations. By developing a rigorous and repeatable sampling protocol, especially with the inclusion and sharing of high-resolution data (fish, benthic, oceanographic) and novel reef visualization products (i.e., large-area 'photomosaics'), we can inform and educate managers and other stakeholders about how their coral reefs function and what is needed to ensure that reefs persist into the future.

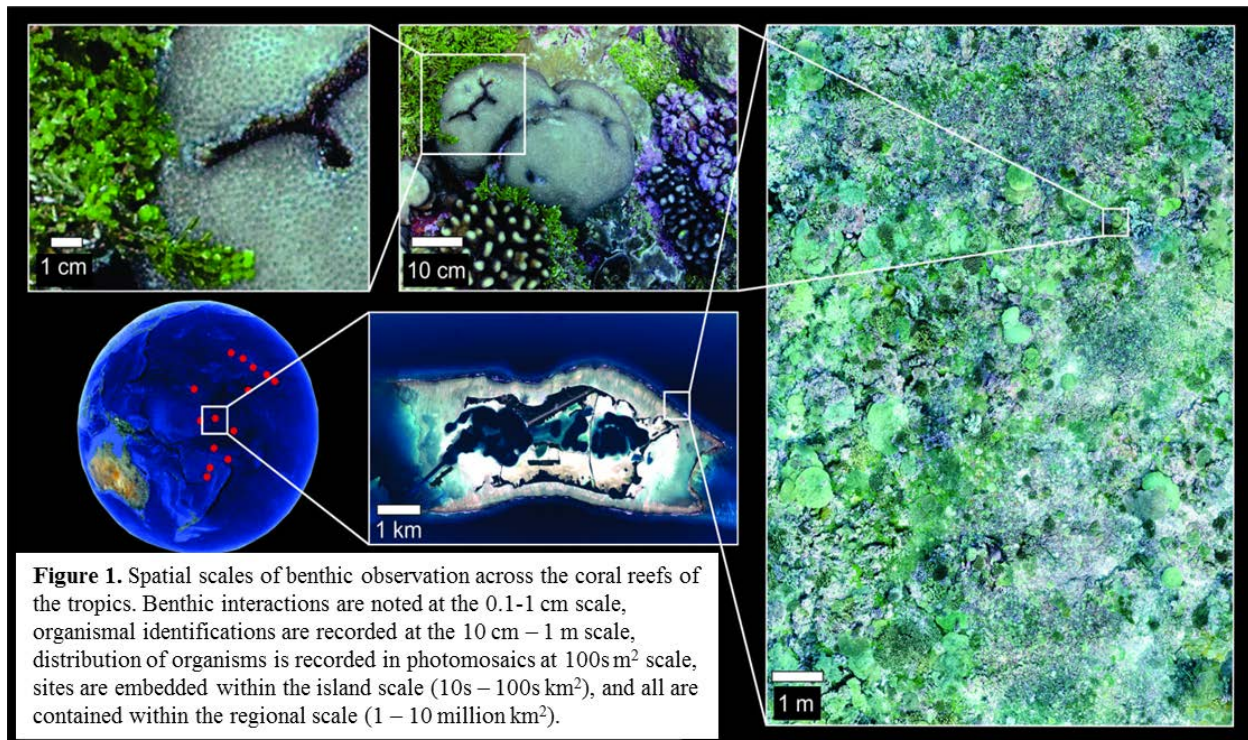

## BACKGROUND

As a consequence of global coral reef decline, new techniques to slow, halt or reverse patterns of degradation have become both a research objective and a management priority. Comprehensive documentation on the causes of coral reef decline indicates that natural and anthropogenic stressors, such as major storms, pollution, and overfishing, interact with global change stressors such as warming and ocean acidification to cause reef loss. Yet we lack clear information regarding the specific pathways involved in these declines.

Several important questions emerge that require novel approaches to answer:

- (i) *How do global stressors (warming, ocean acidification, El Niño) affect coral reefs that experience different natural and anthropogenic conditions? Are remote reefs without human populations better at combating global stressors than reefs adjacent to human settlements?*
- (ii) *Can local management activities (i.e., of fisheries, water quality, watersheds) enhance the ability of a reef to withstand global stress events? Or if not, can these activities increase resilience by facilitating recovery?*
- (iii) *Can active intervention (cultivation of resistant or weedy coral species and transplantation, restoration of herbivore populations, etc.) help to mitigate global impacts on coral reefs?*

***Without clear insights into the mechanisms of change within a coral reef community, it is impossible to resolve debates regarding the most effective means to manage a reef for increased community health.***

## RESEARCH PLAN

The goal of this study is to conduct a large-scale natural experiment, investigating the independent and interactive effects of oceanography and human activities in affecting the structure and dynamics of coral reef communities. The natural experimental design uses islands as statistical replicates, as we select focal islands and reefs to span a diversity of combinations of human activity, oceanographic conditions (principally temperature and nutrient delivery), and island geomorphology. Critically, we are controlling for within-island variables by conducting the core surveys within the same habitat type – leeward, forereef habitat at 7-15m depth.

We employ a collection of standardized approaches to quantify the structure and the workings of each coral reef community. A summary of the methodology follows:

- ***Fishes.*** We use underwater visual census approaches to enumerate the density, size structure, and species composition of the fish assemblage at each reef. The

surveys enable us to quantify critical elements of the size structure, trophic structure, and species diversity. Further, by using techniques of ecological and fisheries science, we provide estimates of potential fisheries production, building off complementary efforts of life history analysis from our group and others.

- **Corals and algae.** We use photographic survey techniques to describe the benthic composition from each reef. Photoquadrats are collected to provide raw data on the percent coverage, species composition, and physiological health of corals, algae, and other benthic taxa. Further, we employ novel approaches of underwater large-area ‘photomosaic’ technology (Figure 1) to document the spatial structure and competitive dynamics of benthic taxa. Our design includes two surveys (separated by 2-3 years) for each site. By re-visiting exact locations and replicating mosaic photography, we have the unprecedented opportunity to track the dynamics of individual corals and patches of algae. In particular, with advanced image analysis we can track how a reef community changes, addressing questions of coral growth, death, and competition (*i – iii*) that are currently unresolved.
- **Oceanographic context.** We use remotely-sensed products (i.e., satellite-derived data, wave models from buoy data) to document core descriptions of the oceanographic context of each island. We will complement these data with a subset of *in situ* data, especially collecting temperature data and collating other data collected by regional partners.
- **Human dimension.** We use a collection of data sources to capture key elements of the human dimension of each island. These data include basic metrics of human population density and distribution, transportation network, and infrastructure. Where available and reliable, we include critical elements of governance structure, legal guidelines, and compliance patterns. We work in concert with the SocMon Pacifika program and other regional partners.

By combining these image-based data with reliable information about the composition of the fish community, the general oceanography, and the human population dynamics at each location, we can elucidate the conditions that are more (or less) conducive to the maintenance of growing and so-called “healthy” coral reefs. These data are becoming increasingly important as the years 2015-2016 represent the world’s largest coral bleaching event ever documented as a result of combined El Nino and global warming.

### ***Applications for conservation and management***

By linking the fates of these reefs to the oceanographic conditions and to the local activities of people, we will be able to start understanding cause-and-effect pathways for reef change. Local-scale marine managers consistently seek information on the “state” of their coral reef, looking for regional comparisons to help guide local management. By

making the data that describe each reef readily available and easy to visualize, there is a terrific opportunity to increase the dialogue between the science and management communities, as well as among managers looking for tangible information to improve their self-management.

Working side-by-side with regional managers and partners in local Nongovernmental Organizations (i.e., OneReef, the Nature Conservancy, Conservation International), we will expand the scientific insights into the state and future of their reef areas.

## **VISION AND CONCEPTS**

### ***Why is this important?***

The Scripps 100 Island Challenge has been designed to fill a critical hole in both the ***science of coral reef ecology*** and the ***practice of coral reef management***. In terms of ***science***, the 100 Island Challenge provides a novel and comprehensive approach to learn about regional and global patterns of reef health. The majority of research in coral reef ecology is conducted at a limited number of sites on the planet, most frequently near to the handful of popular field stations in the tropics (i.e., Jamaica, Moorea, Lizard Island [Australia]). While this work has been important to advance our knowledge about the basics of the biology of organisms on coral reefs, it is much more challenging to learn about regional and global patterns of ecology when studying just one location.

In terms of ***management***, the 100 Island Challenge will offer the scientific insights for conservation and management professionals to insightfully design strategies to maintain (or improve) reef health. In most cases, resource managers work with only a limited amount of information about the resources that they are managing. Even with the engagement of a team of scientists working at their location, these managers may be constrained to a very limited scope of information and insights. Very often, the solutions to management problems come from examples and insights gained at comparable locations that may be far abroad.

Our research effort will produce consistent and inter-comparable data and analyses that will enable reef managers to meaningfully contextualize the structure and happenings of their reef. The science will be developed with a regional and global perspective – considering factors like what makes particular locations special and what opportunities could be capitalized upon based on observations at other sites. By working with partners in each location, the research team will provide the tailored scientific advice through personal discussions that is too often ignored as a priority by coral reef scientists.

Finally, the data themselves will be accessible for consideration by individuals at all training levels. Large-scale photomosaics will be collected from each location and will be shared through public portals, online or through digital document delivery, for

locations with limited internet bandwidth. As such, a manager will be able to see their reef and as well as the reefs of partner sites that may be hundreds or thousands of kilometers away. Learning by seeing has a value that should not be under-appreciated.

### ***What results do we hope to achieve?***

The 100 Island Challenge is founded on the understanding that solutions to the world's environmental problems will not come from 'ivory tower science' or prescriptive 'silver bullet' strategies. There are thousands of coral reefs embedded within hundreds of human cultures, economies, and geographies, and the problems and potential solutions reflect the intricate complexity of these coupled human-natural systems. The value of science is in providing novel and generalizable insights to local resource users and managers about what is known, unknown, and unknowable about the workings of the natural environment in each setting, empowering the intellectual strengths of the users themselves. We view this project as catalytic in broadly expanding the knowledge base and insights of the community of environmental 'soldiers', sharing the capacity of the academy with the many who often reside in professional space that is overlooked by the scientific community.

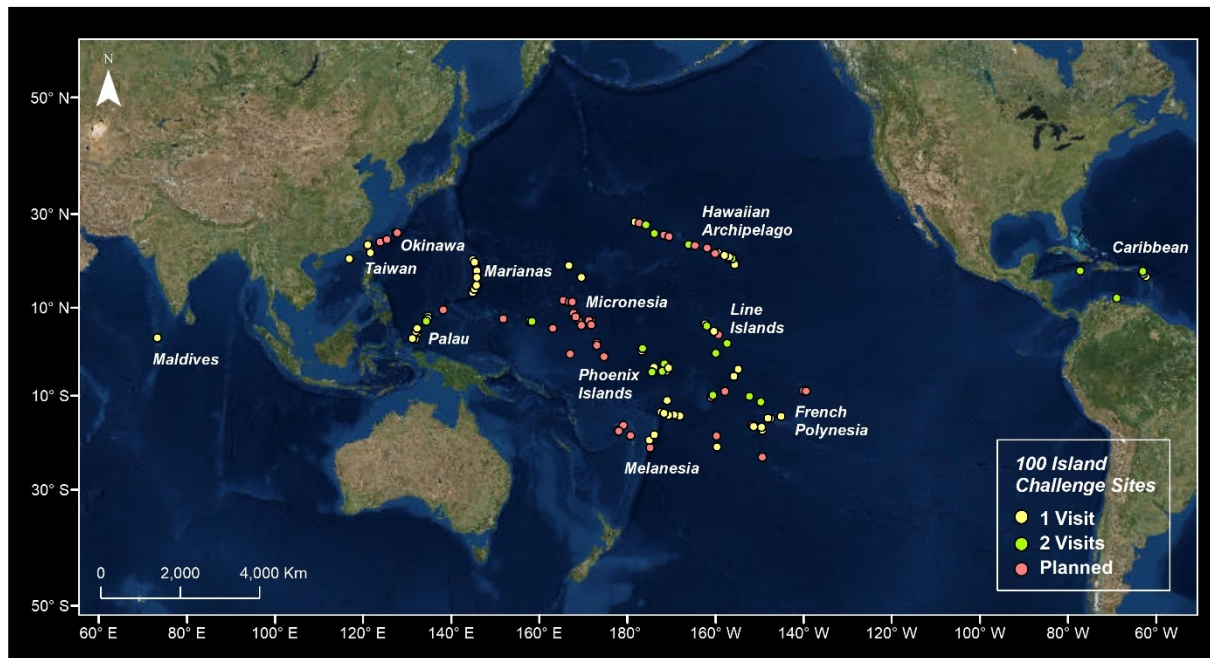

Updated Feb 2019





## Large Area Imagery Overview

### Introduction

The Sandin Lab at The Scripps Institution of Oceanography uses high-resolution imagery collected by divers *in situ* to create detailed 3D models and 2D photomosaics of the benthos. Using a photogrammetric technique called Structure from Motion, we can estimate and reconstruct a 3-dimensional model of a reef scene and create derived 2D photomosaics from the capture of 100's to 1000's of individual overlapping images. This technique can be used to create digital representations of large areas (100's of square meters) of the benthos. Parallel to photoquadrat survey methods, photomosaics can be used to provide snapshots of the percent cover, species composition, and physiological health of corals, algae, and other benthic taxa. However, when applied to large areas photomosaics also allow accurate characterization of the spatial structure and competitive dynamics of benthic organisms analogous to the visual information provided through satellite based-surveys of terrestrial communities. The structural complexity of a reefscape can also be virtually measured using the reconstructed 3D model. Importantly, when repeated over time large area imaging allows for detailed investigations of change at the level of the individual organism as well as providing a rich photographic archive and data source for exploring ecological processes on coral reefs. A major benefit of this approach, especially when applied to large areas, is that several different data types can be collected through a single field method, reducing operational complexity and dive time, while also providing a permanent record of metrics that are otherwise collected *in situ*. Importantly, these models serve as digital archives that allow researchers to virtually revisit reefs to collect new data types and ask new ecological questions.

There are a wide variety of approaches that can be used to collect, create, manipulate and extract data from large area imaging. Here, we outline an approach which allows for the collection of highly replicated and taxonomically refined data at the level of the individual. Ultimately, while choices of plot size, camera type and underwater effort have been tailored to produce data of sufficient quality for our core goals, these methods will provide robust data for a variety of questions.

## **Image collection**

The visual detail captured by large area imaging is a result of the quality of the individual images used to create the composite model. The detail of individual images is largely a function of the type of camera used and the distance from the substrate at which the image was taken. Larger full-frame cameras take higher quality images, but are bulkier, more difficult to use, and more expensive compared to lower quality devices such as GoPro. Similarly, images taken closer to the substrate will tend to have higher detail, yet will cover much less area of the reef and contain less overlap between adjacent images at the same given height from the bottom. As it is necessary to have multiple views of each portion of the reef and high overlap between these images, the choice of camera and height of image collection is critical. Consequently, the spatial extent of the imaged area is based on decisions of desired image quality and dive safety. The plot size (100m<sup>2</sup>) and camera type recommended here (Nikon D7000 or similar), as well as height above the bottom (1.5m) at which we recommend collecting images, has been experimentally determined to maximize replication of coral colonies (100s-1000's per plot) while allowing detailed taxonomic (genus or species level) designations to be made. A single SLR camera or multiple SLR camera systems can be used with lenses set to fixed focal lengths between 18mm and 55mm depending on the application. A wide-angle view of a camera outfitted with an 18mm lens allows for the high overlap between adjacent images, which is necessary for model creation, while higher-resolution images from a camera outfitted with an increased focal length (e.g. 35-55mm) allows for detailed taxonomic designations to be made. Additionally, to facilitate image collection and orient the diver within a survey plot, the camera frame can be equipped with a series of instruments (level, compass, dive computer).

## **Model Creation**

Large area imaging includes both the 2D top-down views of the reef, also termed orthoprojections, and the 3D models from which they are derived. We use the commercially available Structure from Motion (SfM) based software, Agisoft Photoscan, to fuse raw imagery from the 18mm camera and create 3D models comprised of 100's of millions to billions of points, also known as a point cloud. The software relies on multiple highly overlapping images of the same portion of the substrate to recreate the 3D scene. While Agisoft Photoscan can be used to create the orthoprojections via 'meshing' of the 3D point cloud, the output products are prone to error, especially in high relief areas. Using custom software designed by the Computer Science and Engineering Department at UC San Diego (Viscore), we create orthoprojections directly from point clouds, as this produces the most geometrically accurate representation of

the scene (*for further details on orthoprojection creation please contact Nicole Pedersen, nepeders@ucsd.edu*). Importantly, the creation of orthoprojections and downstream extraction of spatially accurate data relies on two critical pieces of information collected in the field during image collection: scale and depth. Scale, whether derived via hand measurements between markers visible inside the plot, or by the placement of calibration bars within the plot area, is necessary to scale both the 3D and 2D models as well as report the associated error of the model. Similarly, to correctly orient the orthoprojection, it is essential to record the depth of at least six targets visible in the plot; however, the greater the number of depth measurements the more accurate the orthoprojection. Further, orthoprojections are enhanced by the collection of raw imagery which is parallel to plane of projection, therefore a level has been affixed to the camera frame to provide divers with a reference when collection imagery. However, in some instances high relief or dramatic depth gradients within plots may necessitate holding the camera off-level to collect images of adequate quality (*see Field Collection SOP, Step 6*).

The rest of this guide features step-by-step instructions for the implementation of the standard operating procedure used by the 100 Island Challenge team. We outline the tools and procedures for the collection and creation of photomosaics as well as the necessary steps for the extraction of ecological data from them. Should you have any questions on any of the content included here please contact Brian Zgliczynski (bzgliczy@ucsd.edu).



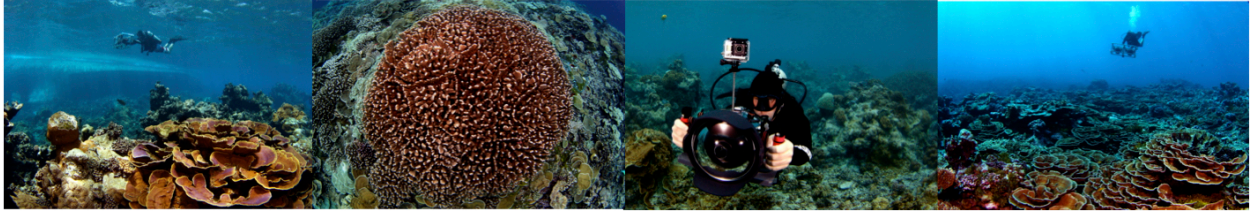

## Large Area Imagery Field Collection Standard Operating Procedure

Please contact either Lindsay Bonito (lbonito@ucsd.edu) or Christopher Sullivan (cjsullivan@ucsd.edu) if you have any questions regarding the Field Collection procedure.

### 3.1 Mosaic Frame Assembly and Camera Installation

The tools and equipment used to conduct photomosaic surveys can span a variety of configurations depending on the goals of survey design. The protocols outlined here are specific to a single SLR Nikon D7000 camera mounted to a custom frame (Figure 2). The camera used to generate photomosaic imagery uses a wide-angle lens (18mm) to ensure high overlap among adjacent images. However, if higher (sub-cm) resolution imagery is required, a moderate focal length lens (24-35mm) setting can be used as long as images are collected with sufficient overlap.

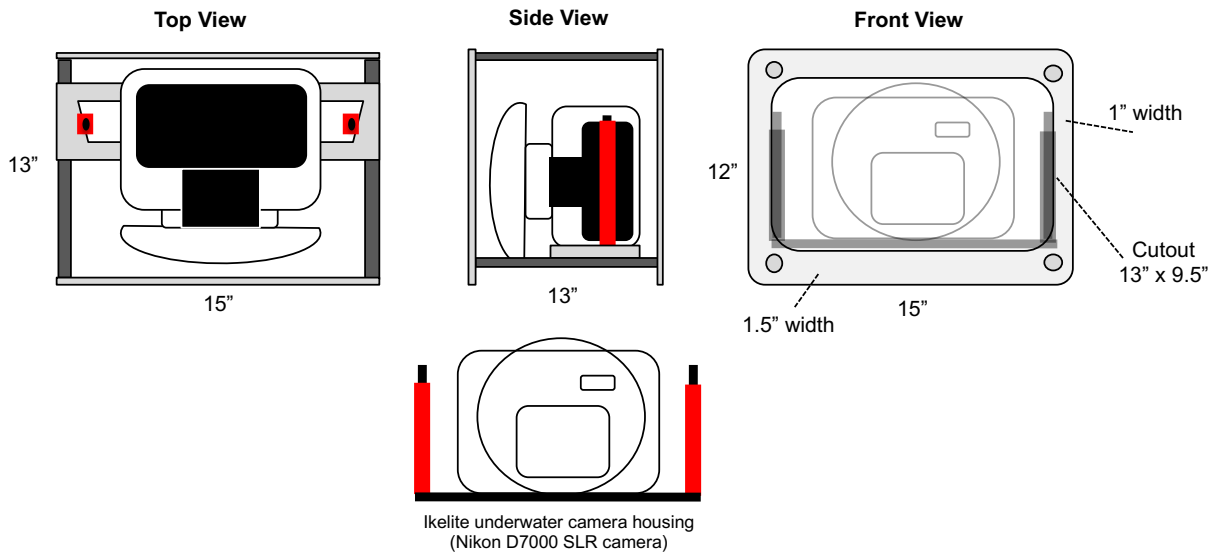

**Figure 2.** Schematic of mosaic camera system including digital SLR camera and frame.

## Materials for Mosaic Rig Assembly

QTY	Description
1	Nikon D7000 SLR camera and AF-s DX zoom-Nikon ED 18-55mm F3.5-5.6G 11 autofocus lens
1	Ikelite underwater camera housing for Nikon D7000 including: modular 8-inch dome, modular 3.5-inch lens extension, SLR-DC underwater camera tray and handles
2	High-capacity storage SD cards
2	Outer frame pieces constructed of ½" black marine grade seaboard
4	Delrin machined and tapped for 3/8" 16 thread support braces
1	Camera tray mount pieces constructed ½" black marine grade seaboard
1	Camera slides and mounts constructed of HPDE

Below are different views of the mosaic rig fully assembled:



- 1. Assemble frame.** Using 8 Stainless Steel Flat Head Phillips Machine Screws (3/8" – 16 thread, 1-1/2" length), connect the two sides of the frame. 2 of the frame columns will already be assembled to the camera plates. The camera plate will already be assembled and ready to be attached to the frame. See camera mounting plates below:

Camera mounting plate with 2 frame columns attached

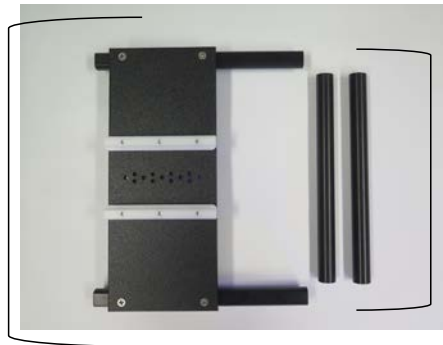

2 'free' frame columns

Mosaic Frame Assembled

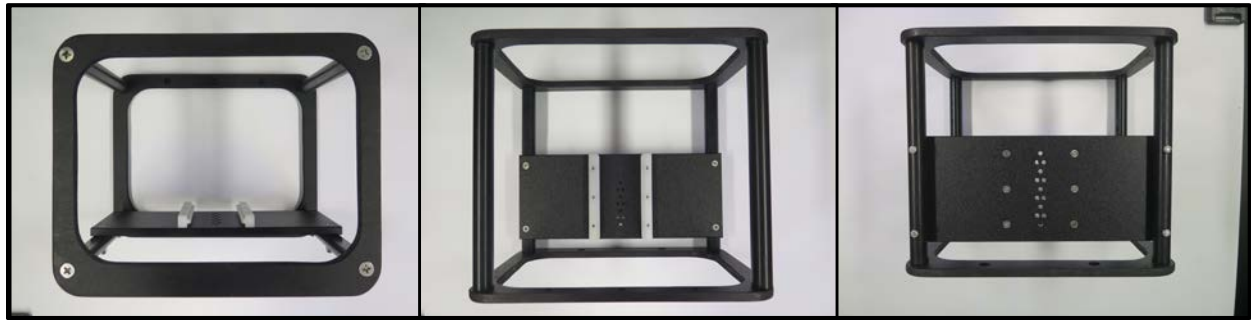

front view

top view

bottom view

- Attach dome to dome port.** Clean the housing, dome, and dome port thoroughly with Kimwipes. Grease both o-rings with silicon lubricant and place the larger o-ring labeled “thread side” around the dome port closest to the threaded area. Place the smaller o-ring on the opposite side. Screw the threaded side of the dome port to the dome so that base of dome port seals against base of dome.

**Ensure that you completely seal the dome port to the dome, as the thread has a very tight fit to the dome, and it takes quite a bit of force to completely seal. We have provided a tension strap to assist in this process.**

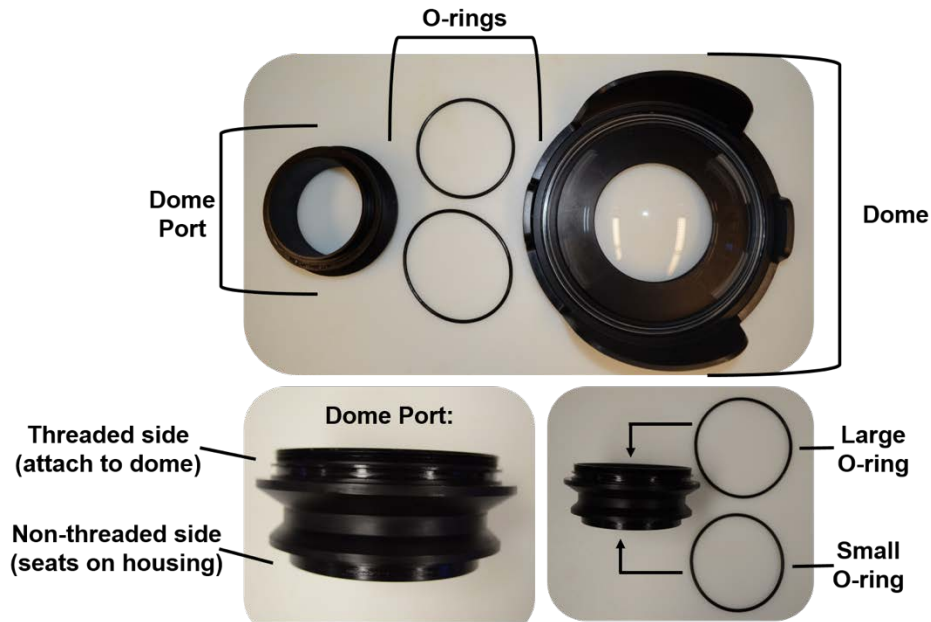

### Ikelite Dome Port Diagrams

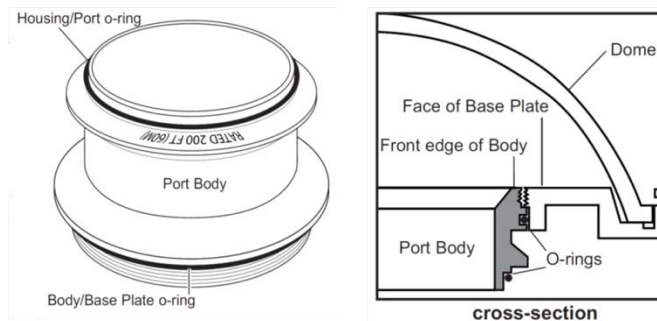

3. **Attach dome to housing.** Seat the dome into the housing and attach with the 4 port locks. Be sure to secure all 4 port locks in locked position. Ensure that locks 'click' into place.

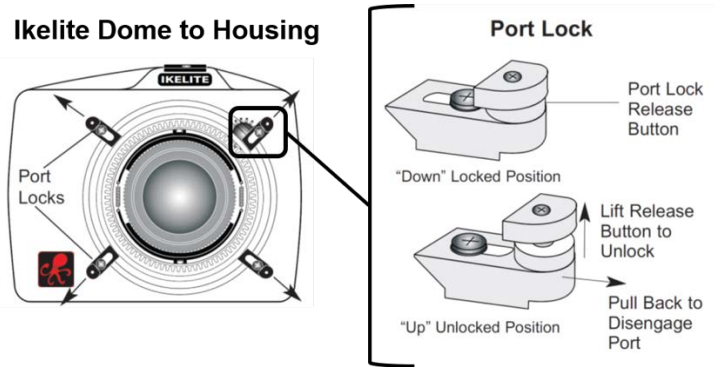

4. **Attach handles and white camera mounting plates to housing.** First, screw the housing handle to the housing using 2 black plastic washers and flathead machine screws. Next, attach the white camera mounting plate to the bottom of the housing handle plate using the 4 Camera Mounting Plate Screws. **\*Make sure that the silver buttons are facing away from the housing and that the hole in the white mounting plate lines up with the single hole in the handles.**

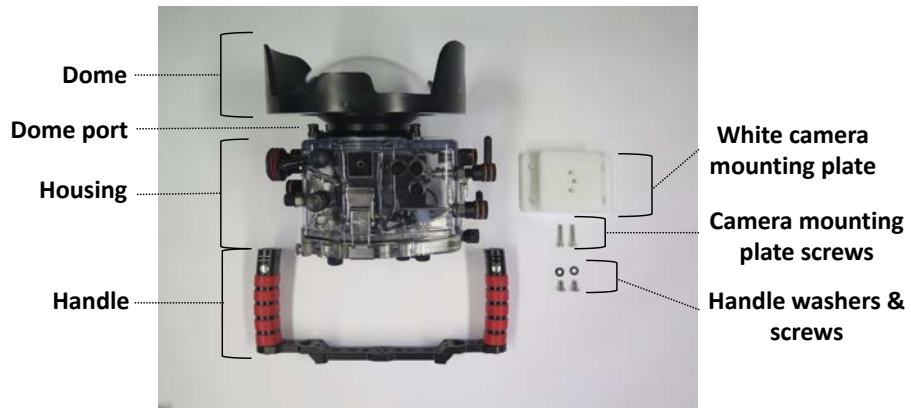

5. **Place cameras inside housings.** Be sure to clean the housing thoroughly with Kimwipes before placing the large o-ring on the back housing panel. Grease the o-ring with silicon lubricant and place the o-ring to seal the housing.
- Open the housing, carefully opening each Lid Snap.** Lid Snaps have a Lock. To open, push Lid Snap Lock forward and lift as shown. Keep pressure on each Lid Snap so it does not fly open quickly.

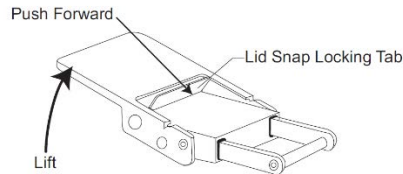

- Attach the Hotshoe and Camera Mounting Bolt.** Slide the Hotshoe Connector all the way forward onto the camera flash mount until it stops. Hotshoe Connector should be attached before the camera is secured with the mounting bolt. Position the camera and lens on the camera tray, and then secure it with the mounting bolt which threads into the camera's tripod socket. Use a flathead screwdriver (recommended) or coin to tighten the mounting bolt so the camera bottom is flush against the tray. The Leveling Screw is factory preset and does not need to be adjusted.

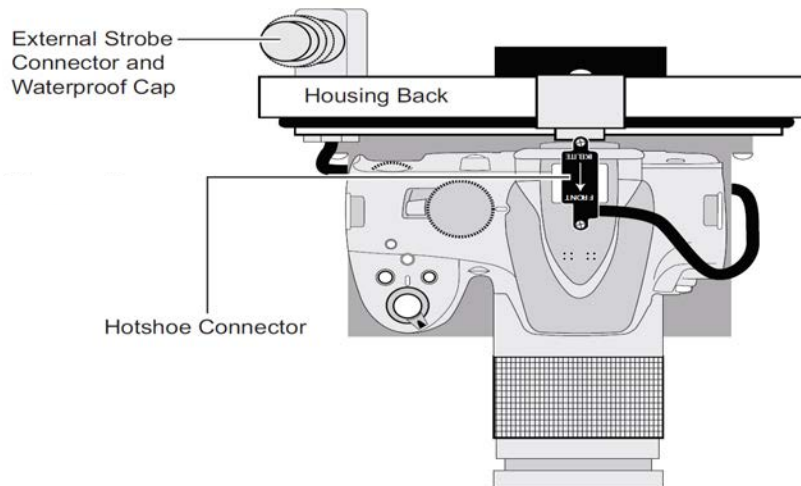

- c. **Install Camera in Housing and Close Housing.** Before installing the camera, make sure housing control levers are out of the way. Pull out on the controls in the front section of the housing, or point them forward away from the back. This will allow the camera to slide in easier. Once the camera is installed and the lid snaps have been closed, return the controls to their operating position.

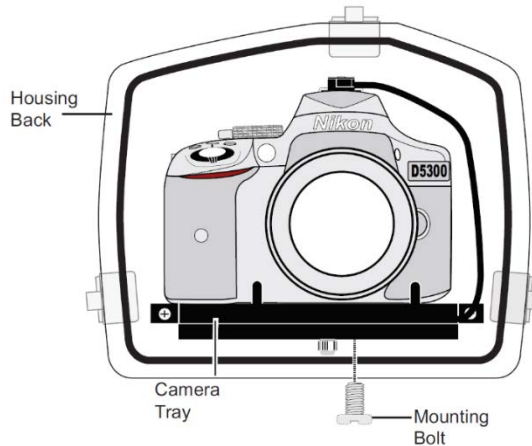

- d. **Conduct final checks before loading into frame.**
- i. **CHECK** each housing control's operation.
  - ii. **CHECK** the main housing o-ring seal (should appear as a dark line around the housing back).
  - iii. **CHECK** Lid Snap Locking Tabs. Make sure they are flipped up.

6. **Install cameras in mosaic rig.** Slide camera housing into the mosaic frame. Line up the white camera plate hole to the holes on the frame. Usually it should line up around the 2<sup>nd</sup> or 3<sup>rd</sup> hole from the front. Tighten the wing nut until it is finger tight.

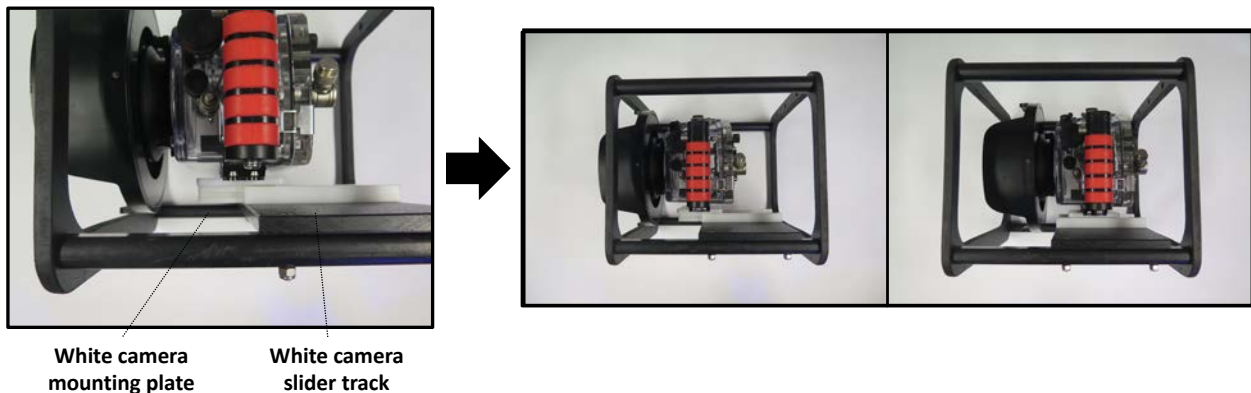

- 7. Secure camera to frame.** Once camera is installed into frame along the sliders, use plastic head thumb screw to secure housing to frame. Be sure to align holes on the mounting plates.

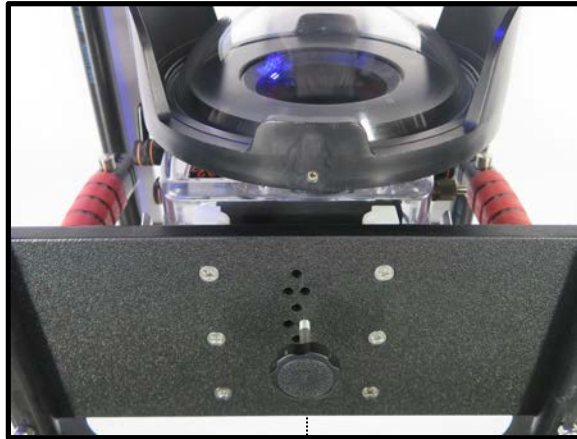

Plastic head thumb screw

## 3.2 Camera Preparation & Settings

We use an optimized set of camera settings that are robust to the dynamic environments that mosaics are typically captured in and require minimal user intervention during image capture. It is necessary to recheck all menu settings each day as they can be changed accidentally. The steps below outline how to access and program all necessary settings through the default menus, however all items have also been made accessible through the customized “My Menu” to minimize the steps needed to check and program camera settings.

### General Camera Prep

1. Camera battery is fully charged
2. Memory cards clear. ***Cards can be formatted in camera***
3. Clean housing
4. Grease O-rings
5. Viewfinder is taped. This blocks sunlight from entering camera, which can disrupt proper function of the internal light meter.

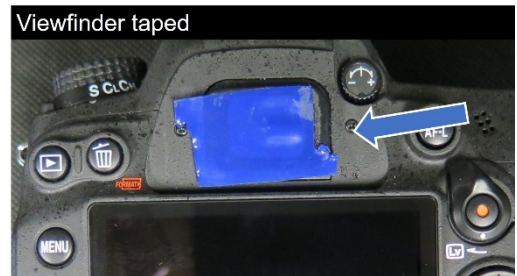

### Nikon Camera Body Settings

1. Set focus dial on Camera Body to **AF**
2. Set shooting mode dial is set to **P**
3. Set release mode dial (the dial below shooting mode dial) to **S**



## Nikon Lens Settings

1. Set SLR zoom lens to 18-35mm, depending on application
2. Set focus switch on Lens to **A**
3. Set VR to **Off**

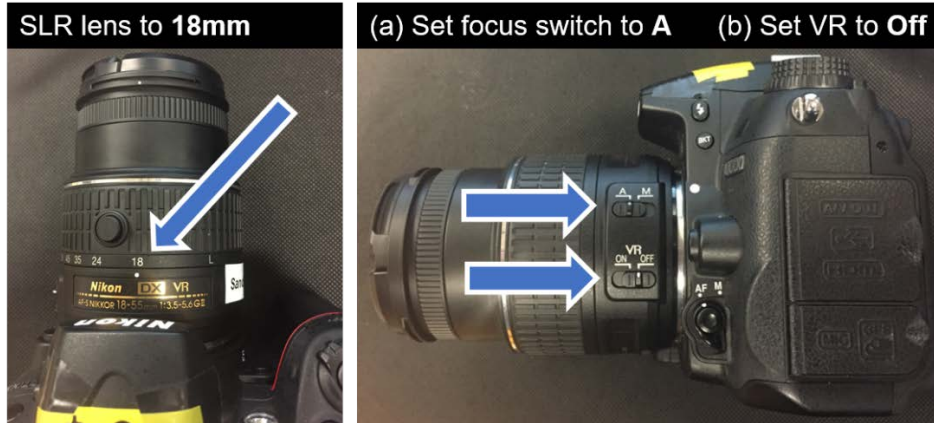

## Nikon Menu Settings

1. Verify live view is off (finger dial, top right corner of view screen). ***If live view is on you will be unable to access many of the menu settings***
2. Autofocus settings
  - a. Top screen is in AF-C mode. ***To change push AF button and spin back finger wheel***
  - b. Autofocus settings:
    - Menu -> Custom Shooting Menu -> Autofocus menu ->
      - a. a1 -> **Focus**
      - b. a2 -> **Focus**
      - c. a6 -> **AF11 11 points**
  - c. Set top screen symbol to a single central point
    - a. To change push AF button and spin front finger wheel



### 3. ISO sensitivity settings:

Menu -> Shooting Menu -> ISO sensitivity settings:

- a. ISO Sensitivity = **400**
- b. Auto ISO Sensitivity control = **ON**
- c. Maximum sensitivity = **3200**
- d. Min shutter speed= **1/200 s**

### 4. File settings

- a. Menu -> Shooting Menu-> Image quality -> **JPEG fine**

### 5. White balance: Auto

- a. Menu -> Shooting Menu -> White Balance-> Auto<sub>1</sub>

### 6. Interval timer settings

- a. Menu -> Shooting Menu -> Interval timer shooting
- b. Choose start time -> **Now**
- c. Interval -> **00:00':01'**
- d. Select interval x no. of shots -> **999x1=0999**
- e. Start -> **Off\***

***\*Turn the interval shooting on once you are ready to start swimming. The only way to stop the interval timer is to power off the camera***



#### **Are you ready to Mosaic?**

Once system is assembled, check you can access all camera controls and menus.

- If you can't access controls, it is usually due to one of the buttons being depressed, **usually the shutter or live view buttons.**
- If the flash is enabled you will not be able to access menus, look for the flash icon on the top screen.
- If you cannot resolve the issue, restart the camera.

### 3.3 Entering the Water with the Cameras

---

The goal of the photomosaic survey protocol is to safely collect images of benthic habitats of focal areas following safety standards identified by the host institution's diving safety program. Once a focal site is identified, divers working as a 2-3 person team enter the water to set-up the mosaic plot and commence collecting imagery in the following manner (See Figure 3 for further clarification).

#### Image Collection Equipment

Qty	Description
1	Mosaic rig
1-2	Dive Slate (Plot Metadata & Calibration Grid) & Road Map
6	Calibration targets
4	Calibration bars (2 targets mounted on pre-measured pole)
1	Transect Tape (30m)
4	Weighted reference floats (1lb)
2	Stainless steel stakes
1	two-part marine epoxy
1	mallet

#### Entering the Water

1. Enter water with dive gear only.
  - a. Place frame into water, keeping the dome level and pointed directly down, submerging completely while divers in water inspect housings for leaks.
  - b. Once the frame is submerged rotate the frame so that dome faces the surface, remove any bubbles from housing and dome and check again for leaks.
  - c. Both divers descend and establish site.



#### **In the event of a flooding, all is not lost.**

The reservoir created by the dome gives you a few seconds to get the camera out of the water. If dome fill with water, quickly remove the frame from the water with special care to keep it level. If the camera does get in contact with water, it is imperative to remove the battery immediately.

### 3.4 Establishing or Resurveying a Site

---

The establishment, geo-referencing and relocation of plots is a critical step in the collection and use of photomosaics, especially for sites that will be subsequently revisited. Regardless if a plot is being established or revisited, it is important take an accurate GPS point and record in the metadata any key features that might facilitate relocation in subsequent surveys. When conducting repeat surveys, it is critical to resurvey the entirety of the original plot area using permanent markers or imagery from previous year's surveys as a guide.

#### Establishing a New Site

##### 1. Plot Selection Characteristics

- a. Minimize depth variation in the plot\*
- b. If you are not installing permanent markers it is helpful to place center markers near readily identified features to aid in plot relocation.

***\*Subject to change based on trip logistics and site characteristics***

##### 2. Setting the Reference Stakes

- a. Reference stakes consist of two 18" long 3/8" diameter 316 stainless steel stakes with sharpened tips driven into the substrate and allow the plot to be relocated and accurately reimaged during subsequent visits. Establish the first stake in an appropriate location (i.e. high point on reef and secure).

- b. While the first member of the dive team marks the site with the reference stake, the second diver uses a transect tape and swims out horizontal to shore along the 10m isobath. Once the diver reaches 10m, a second stake is driven into the substrate to mark the central axis of the mosaic plot (Figure 3).

***In some instances, a suitable location for stake installation will not be available at exactly 10m. If this occurs, please install the stake at the next further location along the transect line.***

- c. Be sure to secure the base of the stake using a quarter to half a stick of 2-part epoxy putty (i.e., Aquamend).

- d. Affix a locking nut to the first stake prior to deployment. This stake will serve as the reference stake, to designate the "left" side of the plot, or starting point. **Take a GPS waypoint from this stake.**

- e. Take an accurate GPS point at the reference stake with the lock nut. This is best done at the end of the dive, where one diver hovers over the stake, and the second diver surfaces to record the GPS position using a hand-held GPS unit. This can be accomplished by mounting a GPS to a float in a waterproof housing or coordinating the collection of a waypoint with the surface support vessel.

## Recovering an Established Site

1. Be sure to bring an extra slate with a color “road map”, an orthomosaic printed on waterproof paper, along with the old plot metadata to assist in the relocation of the mosaic plot.
2. Take an accurate GPS point at the reference stake with the lock nut. This is best done at the end of the dive, where one diver hovers over the stake, and the second diver surfaces to record the GPS position using a hand-held GPS unit. This can be accomplished by mounting a GPS to a float in a waterproof housing or coordinating the collection of a waypoint with the surface support vessel.

***ALWAYS, regardless if plot is new or established, take an accurate GPS point from the reference stake***

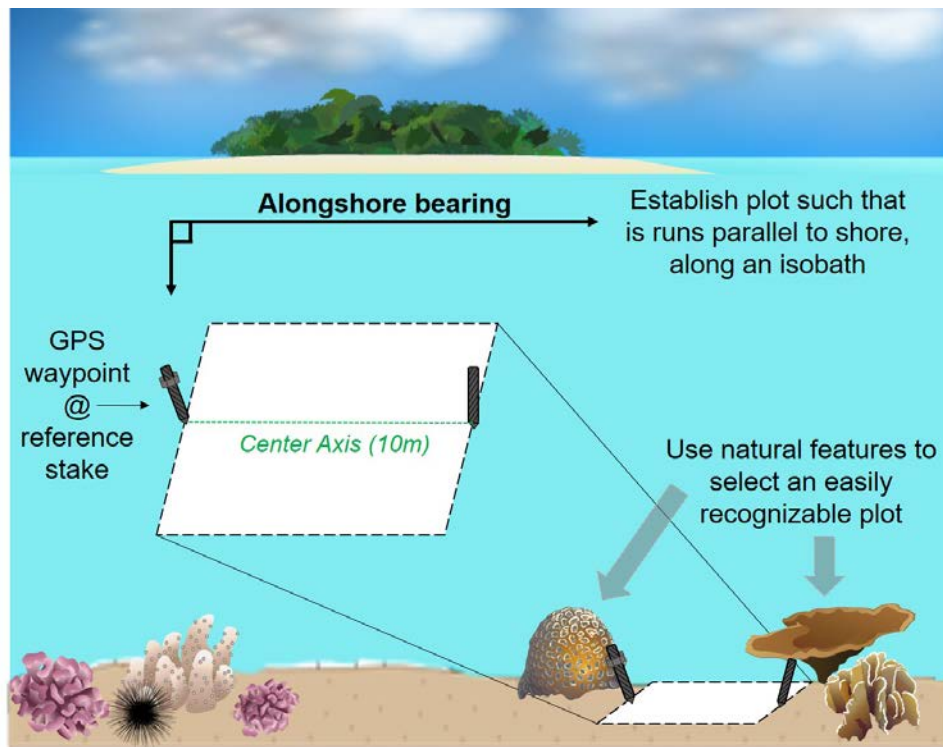

Figure 3. Diagram of mosaic plot setup outlining the preferred orientation of plot.

### 3.5 Plot Setup

Different factors will influence the coordination of the plot setup, including dive team, dive time, and conditions. In a two-diver team (mosaic diver and supporting diver), generally, the supporting diver determines the orientation of the plot and places calibration targets, calibration bars, and reference floats per Figure 5. Both divers then take calibration photos. The mosaic diver then begins collecting images, while the other diver collects measurements, depths, and other associated metadata, carefully avoiding the mosaic diver.

1. Specialized calibration target markers are placed at each corner of the mosaic plot and next to each reference stake (Figure 4). The target markers are labeled with a unique identifier symbol, a unique number, and calibration borders to facilitate automated scale and color correction during post-processing.

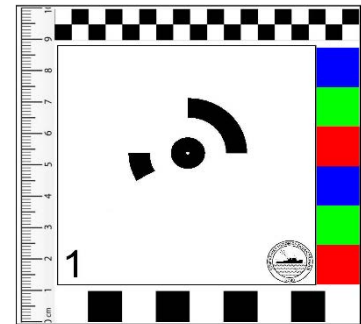

Figure 4. Example calibration target marker

2. The dive team then deploys calibration bars in the each of the 4 quadrants of the mosaic plot (Figure 5). Calibration bars consist of 2 target markers affixed to a PVC pipe such that the center of the two tiles are exactly 50cm apart and are used to scale the final photomosaic.

3. Corner floats are deployed at the corners of the plot to provide a visual reference of the plot area during the survey. Floats should be placed >1m away from the corner markers (Figure 5). Be sure to place floats so that they are as close to the same height above the mean height of the plot (i.e. don't place on pinnacles or in holes).

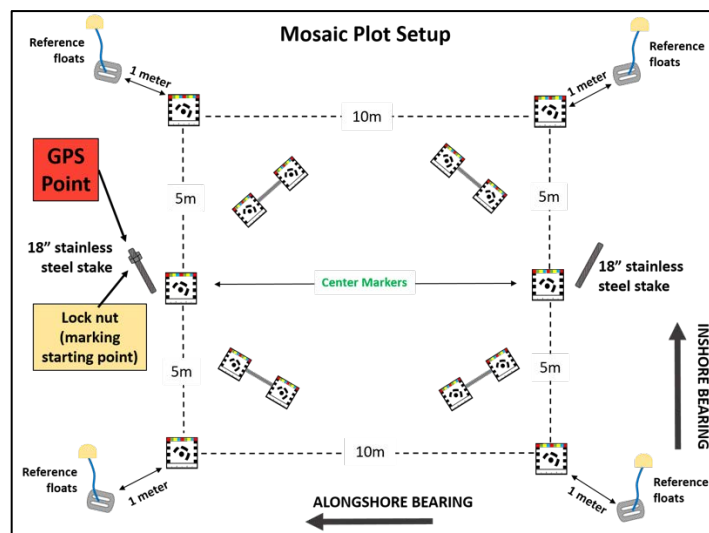

Figure 5. Detailed description of mosaic plot setup identifying the placement of calibration markers and floats.

### 3.6 Image & Measurement Collection

---

Once the plot is established, one member of the dive team prepares the camera system for conducting the mosaic survey. To obtain continuous coverage of the reef floor within a plot, the diver operating the camera system uses the camera in interval timer mode while swimming a gridded pattern approximately 1.5m above the average depth of the plot at speeds sufficient to maintain maximum overlap between adjacent images (Figure 6). Images are captured every second from the DSLR camera. Depending on local conditions a single mosaic survey will take 40-55 minutes to collect and consists of approximately 2500 individual images.

#### Calibration (Divers 1 & 2)

The dive team works together to collect calibration images for the camera using the calibration sheet on the dive slate.



1. Turn the camera on, turn on live view.
2. Take 6 angled pictures of the calibration (see figure below).
3. Review pictures and ensure quality of photos (i.e. in focus).

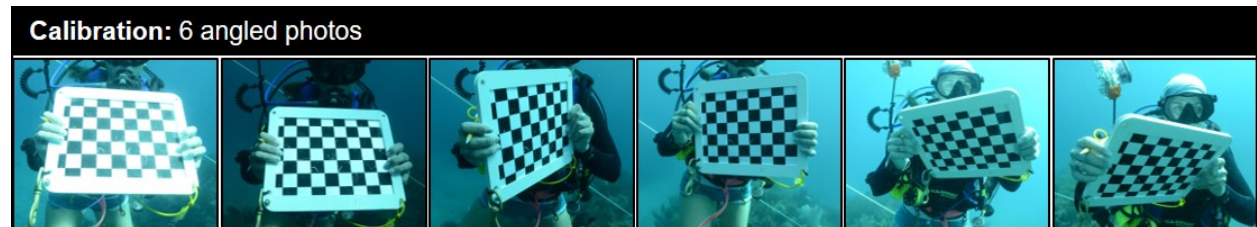

## Image Collection (Diver 1)

1. **Turn on the camera and initiate the interval timers..**

2. **Signal the survey has started.** When you are ready to enter the plot wave hand in front of the camera to create a signal that surveys have started. Due to the focus on the camera and the proximity of your hand it may take a moment for the camera to focus. Make sure you hear the shutter to confirm that a picture has been taken and allow several pictures to be taken.

3. **Swim approximately 1.5m from bottom.**



To aid swimming height set the reference floats so that they are at 1m above the bottom and use these to help guide your depth. It is best to swim 1.5m above the median plot relief (i.e. 1.5m above the average height of coral colonies, not the base of the colonies). At times, topographic complexity will require that you adjust your depth to maintain the same height above the bottom. When adjusting height, make sure to maintain proper camera altitude.

4. **Swim past the reference floats.** Using the reference floats as a guide, begin and end all swaths one body length past plot boundaries. It is important to image an area larger than the plot of interest to ensure that borders are not compromised (i.e. image distortion, sufficient image overlap, etc).

5. **Hold the camera frame level\***. Make efforts to avoid collecting images of blue water or habitat outside of survey area when conducting surveys along steep habitat (i.e., drop-offs) or high habitat complexity (i.e., spur and groove).

**\*In cases of steep slopes, it is important to minimize the amount of blue water in images by holding the camera parallel to the substrate. In these cases, you will be off level.**

6. **Minimum one pass per meter**; for a 10 x 10m plot make at least 10 passes in each direction. If you have more time do more passes.

7. **Maintain a slow swimming speed.** This ensures ~90% overlap between successive images.

8. **Rotate body, not camera rig,** between swaths.



### **If you must pause taking photos for any reason:**

1. Turn camera off (to stop interval timer).
2. Visually note where you stopped (drop markers not recommended).
3. Return to location where the camera was stopped.
4. Starting 1-2 body lengths before the location you stopped at, resume interval timer.

### Restarting cameras

1. The intervalometer takes a maximum of 999 images before it must be restarted. Listen for the camera to stop taking photos as you will exceed the 999 pictures during image collection. Additionally, it takes 16-17 minutes to take 999 images, so it is helpful to use your computer to keep track of the time elapsed since you started the intervalometer.
2. When the intervalometer stops, visually note where the camera stopped. Return to the location of the termination of the interval timer.
3. Starting 1-2 body lengths before the location you stopped at, resume interval timer.

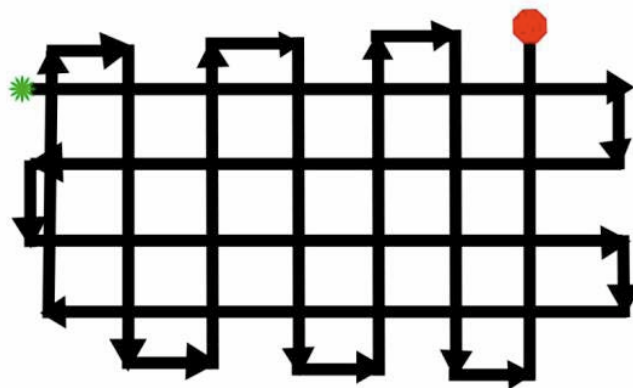

Figure 6. Schematic of diver survey pattern to collect images of mosaic plot.

### Plot Metadata Collection (Diver 2)

Once the mosaic survey has begun, the second diver records the calibration target identification numbers and their associated depths on the mosaic metadata sheet. Target identification is recorded in the box corresponding to the location of the tile in the plot, and the depth is recorded on the line adjacent to the box. The identification numbers for the tiles on the calibration bars are recorded in the box corresponding with tile on the metadata sheet. The orientation of the calibration bars within the plot oftentimes do not match the orientation on the metadata sheet. However, recording the two identification numbers for each stick within its corresponding quadrant of the plot is required. The second diver should also describe the plot and record any unique features that will aid in finding and resurveying the plot during future time points. It is especially important to note the location of identifiable features adjacent to the plot (e.g., sand channels, large corals, spur and groove, etc). Additionally, the second diver should collect site photos of the plot area and close-ups of benthic taxa to serve as reference and taxonomic verification during post-processing.

Island: \_\_\_\_\_  
 Site: \_\_\_\_\_  
 Date: \_\_\_\_\_  
 GPS Unit: \_\_\_\_\_  
 Latitude: \_\_\_\_\_  
 Longitude: \_\_\_\_\_  
 Instruments Deployed: \_\_\_\_\_  
 Instruments Retrieved: \_\_\_\_\_  
 Notes: \_\_\_\_\_

P5 depth \_\_\_\_\_  
 P4 depth \_\_\_\_\_  
 P6 depth \_\_\_\_\_ 10m \_\_\_\_\_ P3 depth \_\_\_\_\_  
 P1 depth \_\_\_\_\_ P2 depth \_\_\_\_\_

INSHORE BEARING:  
 ALONGSHORE BEARING:

Figure 7. Plot metadata sheet (full-size version in Appendix II).

### Plot Clean-up & GPS Waypoint Collection (Divers 1 & 2)

Once the photomosaic survey is completed, the dive team works together to retrieve the markers and floats before returning to the surface. Prior to departing the site the dive team uses a GPS to mark the location of the start point permanent marker by snorkeling above plot using a handheld GPS or coordinating with a surface support team to collect the location of the plot.

## Common issues While Diving

### 1. Steep slope

It is difficult to operate the mosaic frame and equalize on plots that have too great of a depth change. In these situations, it is highly recommended to prioritize a single lawnmower swath parallel to the reef crest (no perpendicular passes). To compensate for the lack of an orthogonal swath conduct as many passes as possible (20+) & swim slowly to maintain high overlap.

### 2. Strong current

Any current above 0.5kt can make operating the mosaic frame very difficult. It is advisable to check local tides and familiarize yourself with local current patterns during dive planning or site selection. A quick surface swim at each site to gauge the current is also advised.

### 3. Strong surge

Any surge above 3' can make operating the mosaic frame very difficult as it requires the diver to keep the camera frame in place along the axis of the survey swath while the diver moves back and forth with the surge. If you are unable to judge the strength of the surge until it is too late and have the mosaic rig at depth, (if you feel it is safe) conduct a single lawnmower swath parallel to the predominant swell direction (to help alleviate overall fatigue).

### 4. Interval Timer Issues

At times the interval timer may stop before the 999 image sequence completes, or may take images at irregular intervals for a number of reasons, including the following:

a. The lens may be having trouble focusing. Check the dome for bubbles or adjust swimming speed or distance from the bottom to facilitate the camera to focus. If problem continues be sure to allow for more overlap during survey.

b. Memory card issues. When the SD cards begin to fail, the interval shooting period lengthens to greater than 1 second, or stops completely. If this happens, switch cards if possible and flag that memory card so the appropriate staff can deal with the equipment back in the lab.

c. If all else fails, turn the camera on and off. Select the menu button and reset the interval timer. In some instances, attempts to start the interval timer will not work. Repeating the steps to start the interval timer through the Menu function often resolves the issue.

## 3.7 Clean Up & Camera Maintenance

---

### Camera Housing Care

At the end of every dive day, the mosaic rig needs to be rinsed off and the camera housing needs to soak in fresh water for at least 5 minutes. If at all possible, under running water, depress every control button on the housing multiple times to work out any salt and sand that may have gotten trapped. Dry housing with clean towel prior to opening housing. Once the camera has been removed, place housing in clean space (preferably in an air-conditioned room) and allow to air dry while digital imagery is downloaded.



*If you have sticky pushbuttons*

Soak the housing in a mild soap solution and operate the pushbuttons repeatedly while the housing is submerged. Dry the housing off and rub a small amount of silicone lubricant on the outsides of the pushbuttons. Operate the pushbuttons several times to work the lubricant in.

### Dome & O-ring Maintenance

Once the dome has been attached to the dome port at the start of the trip, in most cases it can be left in place until the completion of the trip. However, if operating in high sediment environments or you find that the o-ring needs care, use the strap wrench to loosen the dome from the dome port. The seal between the dome port and housing should be checked on a regular basis to ensure a proper seal and port lock functioning.

Every day use a Kimwipe to clean the o-ring and surrounding area of the housing door. Re-lube the main camera body o-ring with a thin layer of silicone grease and be sure the area and o-ring is free of any small debris (i.e. hair, sand) before replacing cameras.

## 3.8 Data Download

---

Upon returning from field survey all image files are downloaded to 2 external storage devices (i.e., hard drives) using a folder naming convention consistent with the metadata recorded from each site. Separate digital files by specific camera (18mm, site camera, etc) within the folder for each survey site.

### Downloading images

1. File storage architecture is included with the external hard drives to store data.

Structure is as follows:

- a. Create a folder for the trip (i.e. NLI\_2018) ->
  - b. Within the trip folder create a folder for each island (i.e. JARVIS) ->
  - c. Within each island folder create a folder for each site (i.e. JAR\_02) where images were collected, that includes the date (YYYYMMDD) (i.e. JAR\_02\_20180305)->
  - d. Within the site folder create the following folders: 18mm, Site Photos
    - i. Copy and paste these folders into each of the site folders you created.
2. Downloading images from camera storage cards:
- a. Make sure all hard drives are formatted to EX-FAT before using the drive.
  - b. The Nikon camera puts images into successively numbered folders, each with 999 images.
  - c. It will start renumbering images after image 9999 and will create a new folder after image 9999 (starting with image 0001) even if the folder containing image 9999 does not have 999 images (in order to prevent overlapping file names in a single folder).
    - i. Pay attention to this number scheme when downloading as it could cause issues with image sequence. Do not combine images from the same dive into the same folder if the counter has restarted as this will corrupt the image sequence. However, if you do so, you can use the time stamp to correctly reorganize.
  - d. Successive dives will often be in the same folder.
    - i. Even if the time is not set correctly, you can use the time stamp and interval between the dives to separate the groups of images. Remember, images will always start with the calibration photos.
  - e. Download to the corresponding site folders on the drive using copy and paste.
  - f. After the transfer, backup to the alternate drive.
  - g. After backup, format the memory card so they are empty the next day, as this will avoid any confusion locating the correct images the following day.



1. **Expedition** - Use a short name to distinguish expedition name. Generally, this code should represent the region where the work was completed (i.e. MHI = Main Hawaiian Islands or NLI = Northern Line Islands).
2. **Island** - Use a 3-letter code to distinguish island name. Use lookup table, do not create your own (i.e. MOL = Molokini; MOI = Molokai).
3. **Site\_Date** - Use a 3-letter island code and numbering system to distinguish site name. This will include the island code again, the site number (or name in some cases) and the date (YYYYMMDD) (i.e. HAW\_048\_20160721).

**The resulting database storage system structure:**

MHI\_2016\HAW\HAW\_048\_20160721\18mm

# Appendix I

## Mosaic Hardware

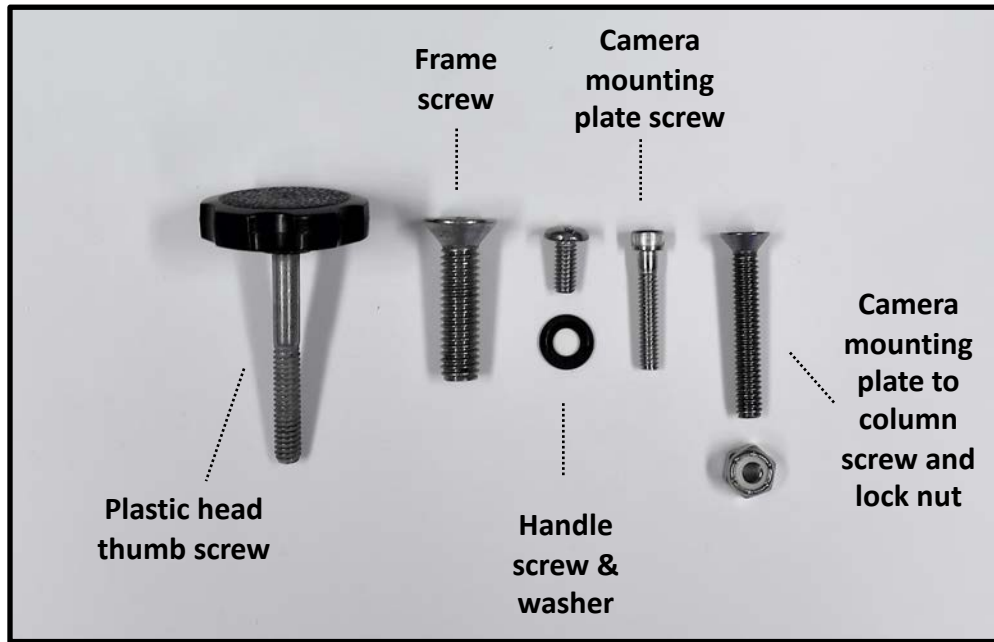

Qty	Name	Description
1	Wing nut (short)	3" long wing nut
8	Frame bolts	18-8 Flathead Stainless Steel Phillips Flat Head Screws, 3/8"-16 Thread Size, 1-1/2" Long
2	Handle screw & washer	12-24 x 1/2-inch stainless steel screws
4	Camera mounting plate screw	18-8 Stainless Steel Phillips Flat Head Screws, 1/4"-20 Thread Size, 1/2" Long
4	Plate/column screw & lock nut	18-8 Stainless Steel Phillips Flat Head Screws, 1/4"-20 Thread Size, 1-3/4" Long

# Appendix II

## Plot Metadata Sheet

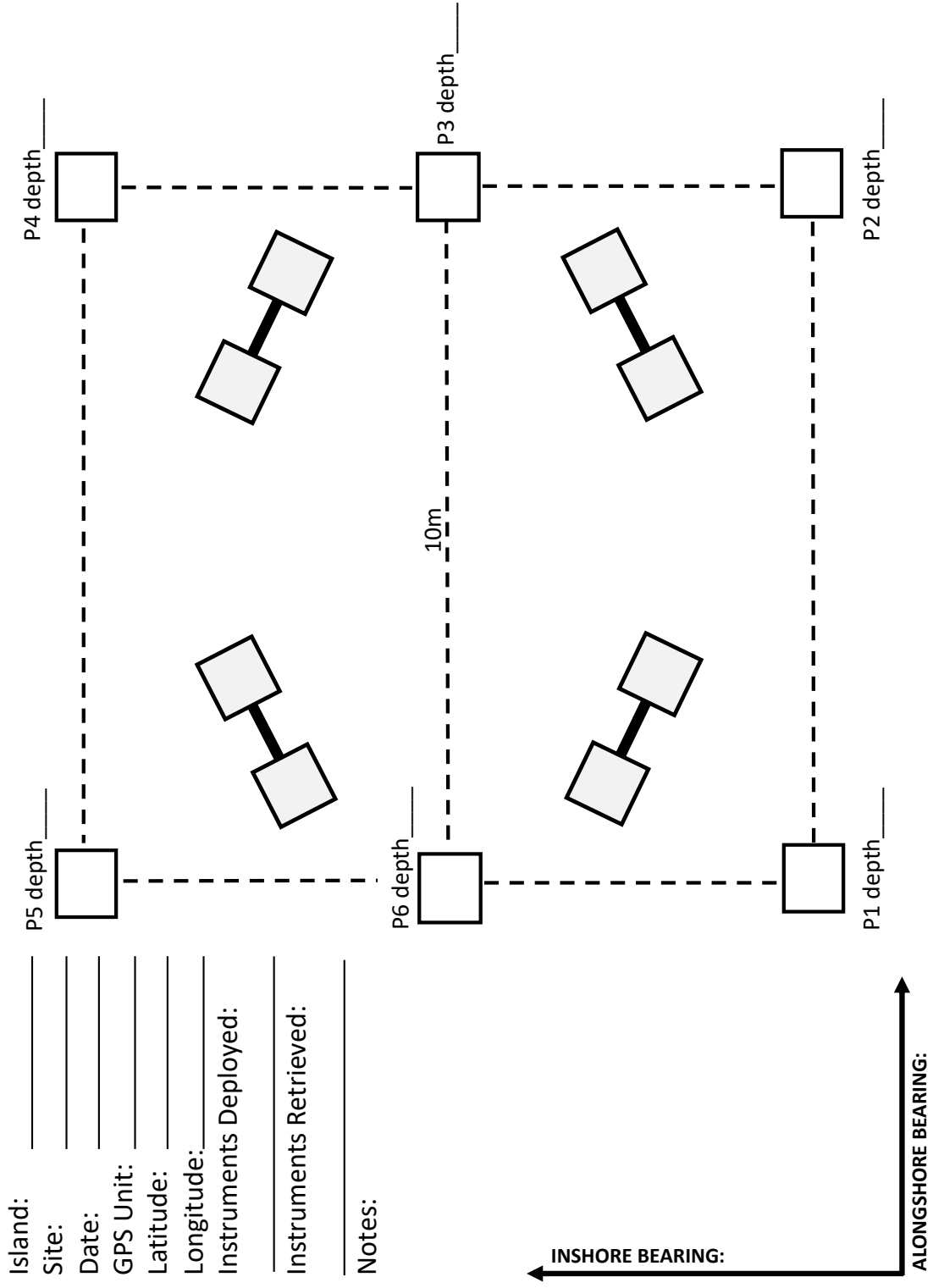



# Appendix IV

## Calibration Sheet

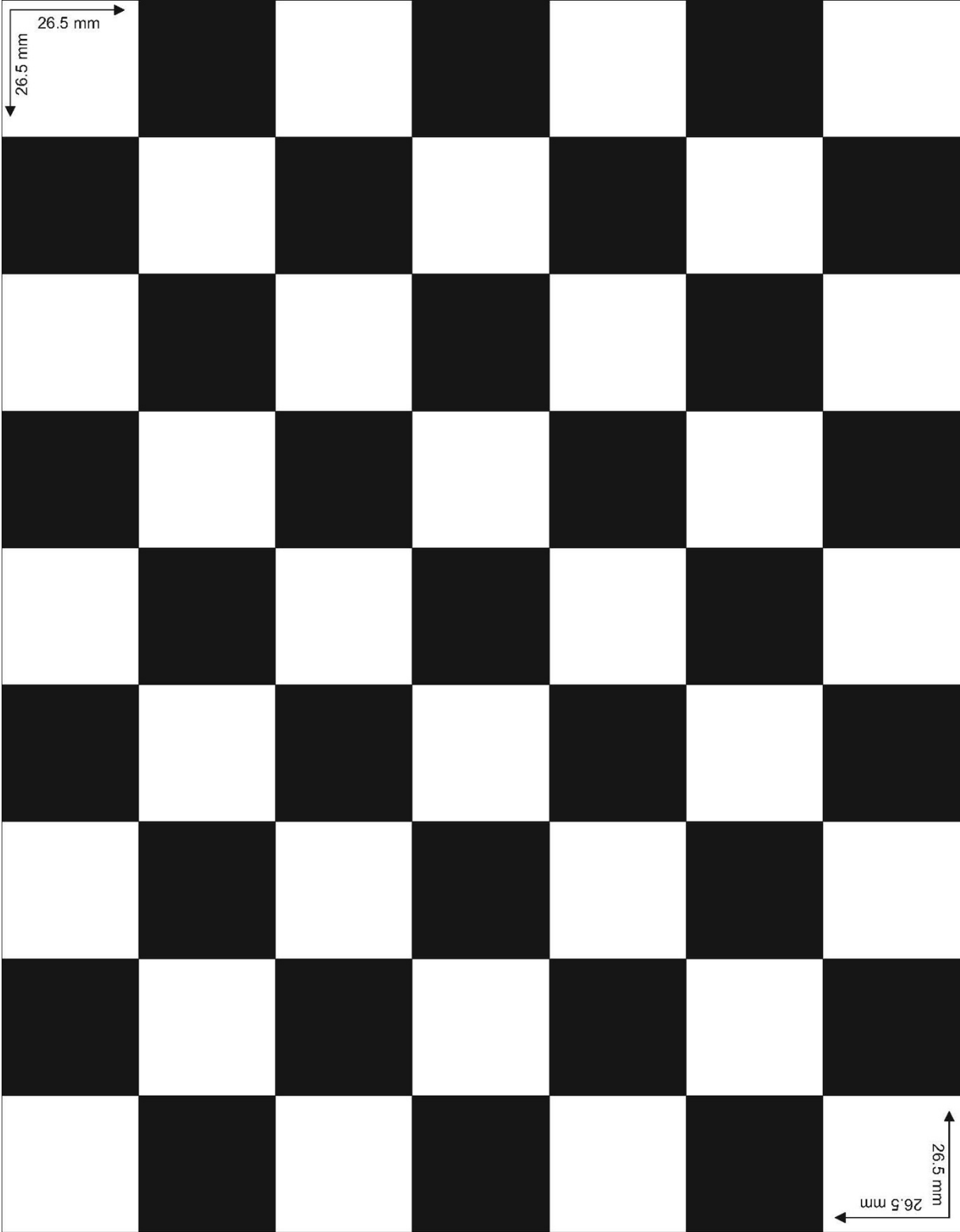

# Appendix V

## Calibration Target

